

AMT-A0236 0.3 GHz to 20 GHz Broadband Medium Power with Low Noise Amplifier

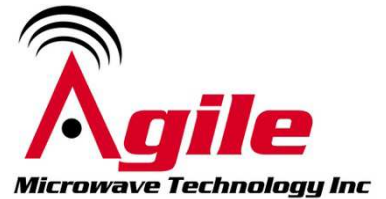

Data Sheet

Features

- 0.3 GHz to 20 GHz Frequency Range
- Typical P1dB power > +24 to +20 dBm
- Gain 18 dB Typical Positive gain slope
- Gain Flatness ± 1.5 dB Typical
- 2.7 dB Typical Noise Figure
- Internally Regulated
- Operates from Single +10 to +12V Supply
- Unconditionally Stable
- Compact Housing



Description

The AMT-A0236 is a +23 dBm P1dB Broadband medium power amplifier in a compact size. The performance is achieved through the use of AMTI's proprietary matching technology and latest in GaAs technology. The amplifier I/Os are Internally matched to 50 Ohms and DC Blocked. The AMT-A0236 is ideal for use as medium power with low noise for test equipment, Communication systems or where broadband amplification and power are required without adding significant noise in a Hi-Rel communications system for Commercial or Military applications

Applications

- Test Equipment
- EW Systems
- Lab Applications
- Radar

MAXIMUM RATINGS¹

EAR99 NLR

Parameter	Symbol	Units	MIN	MAX
Operating Temperature – Case	T _{MO}	° C	-40	+75
Storage Temperature - Case	T _{MS}	° C	-40	+125
RF Input power (CW)	P _{in}	dBm		+20
Die T _{Junction}	T _J	° C		+150
Positive Supply Voltage	V _{+SS}	V		+13

Appropriate Heat sink must be used

1.Stresses above those listed under "Absolute Maximum Rating" may cause permanent damage to the device. This is a stress rating only and functional operation of the device at these or any other conditions above those indicated in the operational sections of this specification is not implied. Exposure to absolute maximum rating conditions for extended periods may affect device reliability.

ELECTRICAL SPECIFICATIONS @ 23°C

Parameter	Conditions	Units	MIN	Typical	MAX
Frequency Range		GHz	0.3		20
Gain	Small Signal	dB	16	18	
Gain Flatness		dB		±1.5	±2
Noise Figure		dB		2.7	6.5
Output Power (P1dB)	1 to 16 GHz	dBm	+20	+23	
OIP3	OIP3 @ 10 GHz Two tone F1-F2= 10MHz	dB		30	
RF Input Impedance	Reference to 50 ohms VSWR			1.5:1	2.2:1
RF Output Impedance	Reference to 50 ohms VSWR			1.5:1	2.2:1
Supply Voltage Positive:		V		+12	
Supply Current Positive:	Small signal	mA		180	250

Notes:

1/ Unconditional Stability

P1dB may be lower from 16 to 20 GHz +19 dBm min

Customized configurations of the above specifications are available

Typical S-Parameters @ 23°C

CH1 LOG 10 dB/ REF 0 dB
S11 1:-17.554 dB .500 000 000 GHz

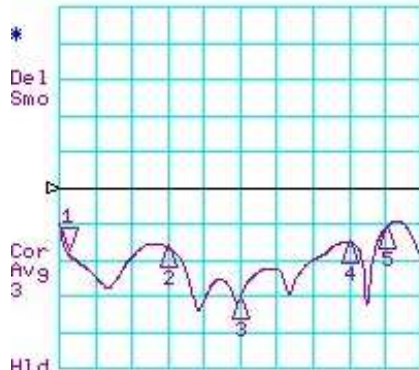

CH1 Markers
2:-16.291 dB
6.00000 GHz
3:-30.513 dB
10.0000 GHz
4:-15.046 dB
16.0000 GHz
5:-11.050 dB
18.0000 GHz

START 100.000 MHz STOP 20000.000 MHz

CH3 LOG 10 dB/ REF 0 dB
S12 1:-54.228 dB .500 000 000 GHz

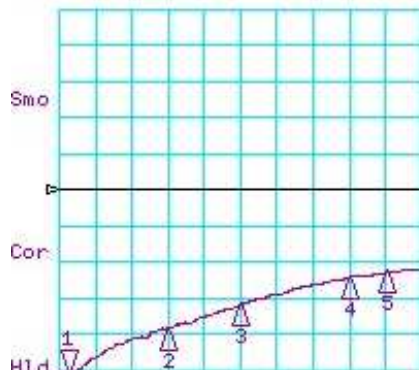

CH3 Markers
2:-38.397 dB
6.00000 GHz
3:-32.095 dB
10.0000 GHz
4:-24.238 dB
16.0000 GHz
5:-22.981 dB
18.0000 GHz

START 100.000 MHz STOP 20000.000 MHz

CH2 LOG 5 dB/ REF 0 dB
S21 1:17.362 dB .500 000 000 GHz

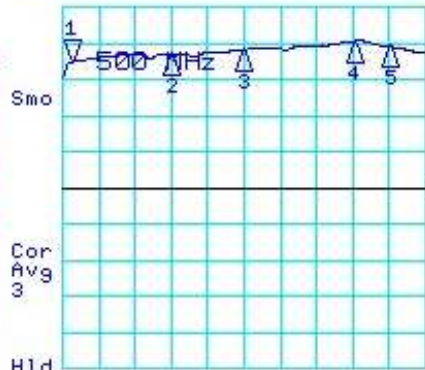

CH2 Markers
2:18.560 dB
6.00000 GHz
3:18.998 dB
10.0000 GHz
4:20.326 dB
16.0000 GHz
5:19.573 dB
18.0000 GHz

START 100.000 MHz STOP 20000.000 MHz

CH4 LOG 10 dB/ REF 0 dB
S22 1:-22.625 dB .500 000 000 GHz

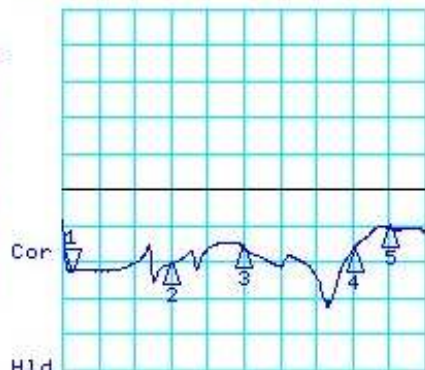

CH4 Markers
2:-20.498 dB
6.00000 GHz
3:-15.848 dB
10.0000 GHz
4:-16.749 dB
16.0000 GHz
5:-10.249 dB
18.0000 GHz

START 100.000 MHz STOP 20000.000 MHz

Typical Noise Figure @ 23°C

Agilent

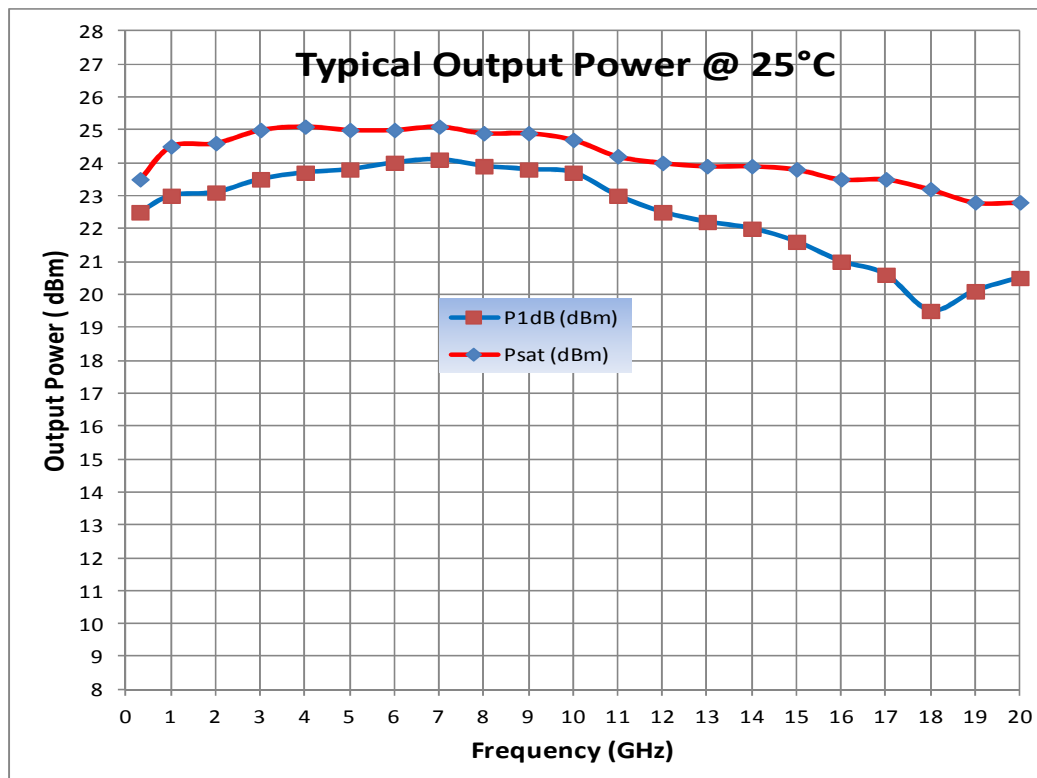
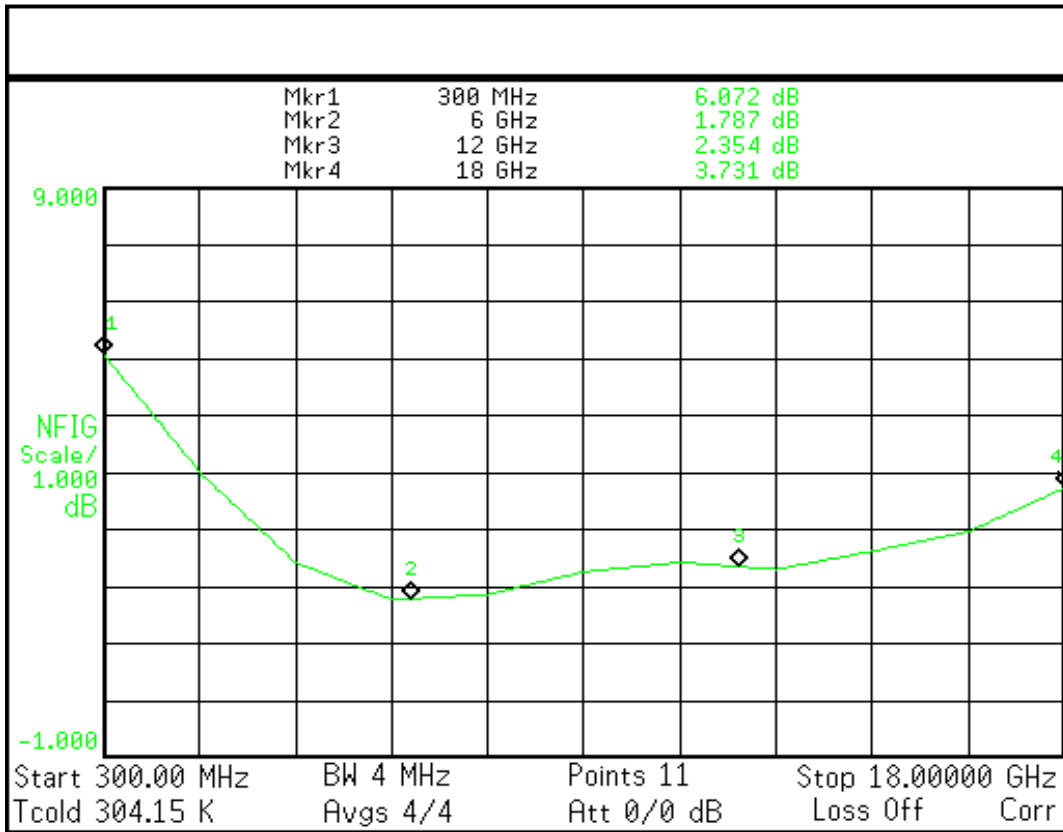

Package Outline M084: SMA Connectorized mm(inches)

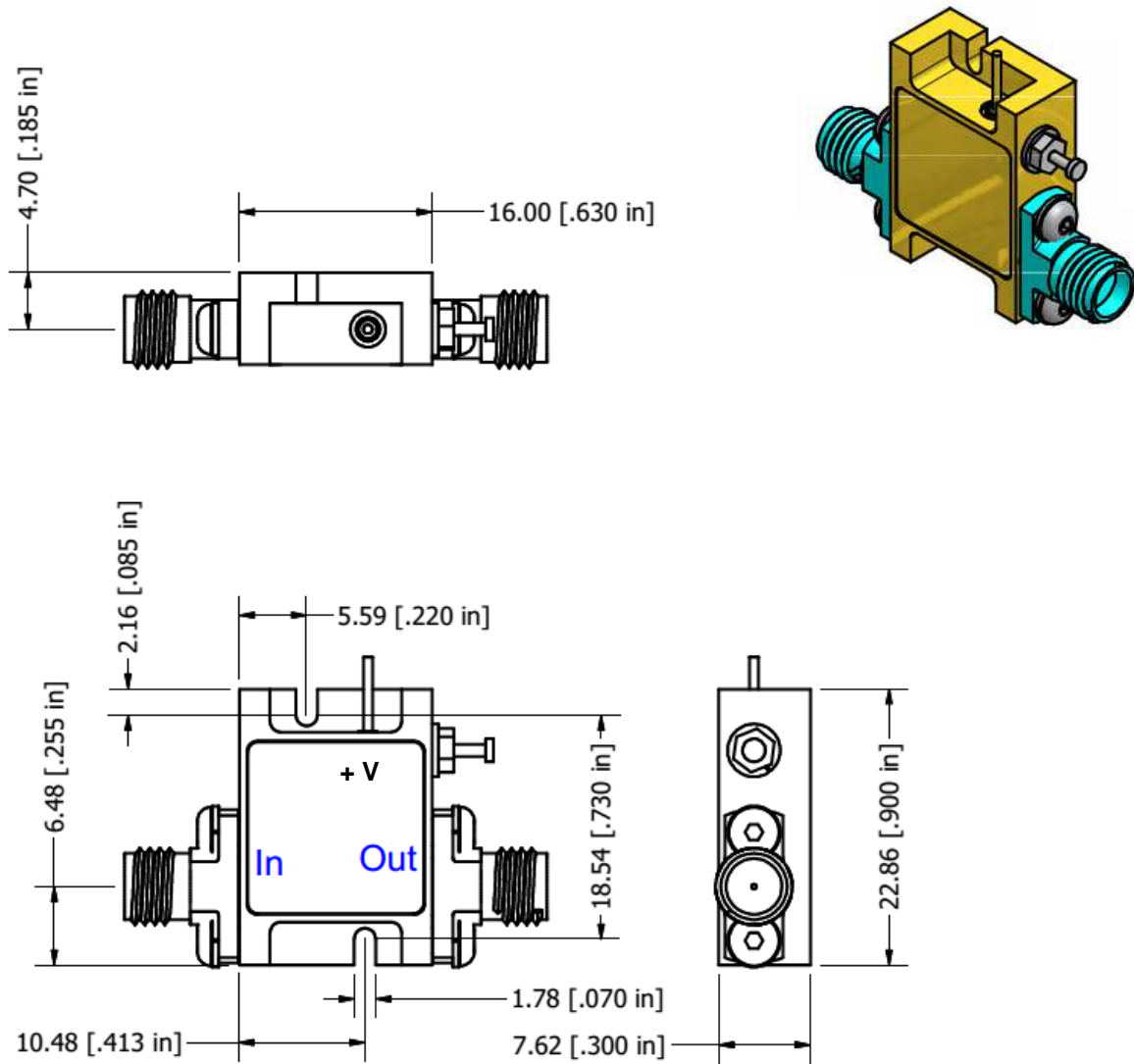

Field replaceable SMA Connectors, Removable Ground Slug

Note: The unit must be attached to proper heat sink

Model Number	Description	Hermeticity	Package
AMT-A0142	SMA Female	Non-Hermetic	Outline: M084

Contact us for custom configurations and special requirements.

Our highly experienced team of engineers can quickly identify and implement innovative solutions using latest technology to improve performance and reduce cost.

- Add additional functionality: Input limiter, Temperature compensation, Amplitude/Phase matching, Amplitude/Phase Tracking, Automatic Gain control, Gain sloping, Bypass path, Specific supply voltage, Regulation, Power detector, Health status, and others
- Integrated: Filters, Switches, Limiter, Digital attenuator, Phase shifter, Microcontroller, Multiple amplifiers, Switch matrix, Comb generators and others
- Mechanical: Custom packages - Surface Mount, Connectorized, Waveguide, Carrier, Drop-in, Hermetic and others

Agile Microwave Technology Inc is the logical choice for all your commercial or military RF/Microwave components/module requirements.

Contact Information:

**101 Bloomingdale Road
Hicksville, NY 11801**

Phone: (516) 931-1760

Fax: (212) 374-1153

info@agilemwt.com



www.agilemwt.com

AMTI reserves the right to change at any time without notice the design, specifications, function/form or availability of its products described herein. The buyer/customer has the responsibility to validate the performance for their applications. No liability is assumed as result of use of this product and no patent licenses are implied. AMTI reserves all rights .