

# AMT-A0065 7 GHz to 9 GHz Low Noise Amplifier

## Data Sheet

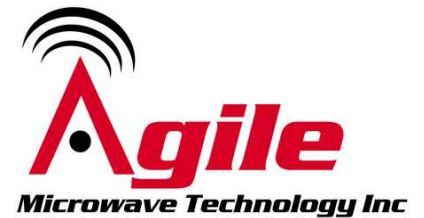

## Features

- 7 GHz to 9 GHz Frequency Range
- Typical Noise Figure < 1.1 dB
- Typical Gain 34 dB
- Gain Flatness <  $\pm 1$  dB
- P1dB +13 dBm Typical
- Internally Regulated
- Operates from a Single Supply
- Unconditionally Stable
- State-of-the-Art GaAs Technology

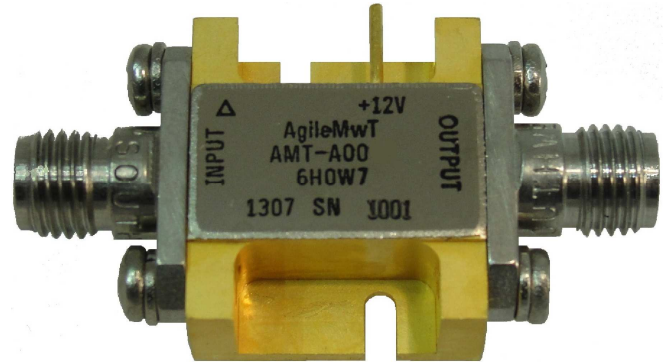

## Description

The AMT-A0065 is a Low Noise amplifier with very low noise figure over the full frequency range. The performance is achieved through the use of AMTI's proprietary technology. The amplifier I/Os are Internally matched to 50 Ohms. The AMT-A0065 is ideal for use as Front End of receiver system, or where amplification is required without adding excessive noise in a Hi-Rel communications system for Commercial or Military applications.

## Applications

- Receiver front end,
- Radar
- Communication systems
- Microwave Radio systems
- Test Equipment

## MAXIMUM RATINGS<sup>1</sup>

Parameter	Symbol	Units	MIN	MAX
Operating Temperature – Case	$T_{MO}$	$^{\circ}C$	-40	+85
Storage Temperature - Case	$T_{MS}$	$^{\circ}C$	-55	+150
RF Input power (CW)	$P_{in}$	dBm		+10
Die $T_{Junction}$	$T_J$	$^{\circ}C$		+150
Positive Supply Voltage	$V_{+SS}$	V		+12.5

1. Stresses above those listed under "Absolute Maximum Rating" may cause permanent damage to the device. This is a stress rating only and functional operation of the device at these or any other conditions above those indicated in the operational sections of this specification is not implied. Exposure to absolute maximum rating conditions for extended periods may affect device reliability.

## ELECTRICAL SPECIFICATIONS @ 23°C

Parameter	Conditions	Units	MIN	Typical	MAX
Frequency Range		GHz	7		9
Gain	Small Signal	dB	30	34	
Gain Flatness		dB		±0.7	± 1
Input Power	CW, without damage	dBm	10		
Output Power (P1dB)	1 dB compression point @ 8 GHz	dBm	10	13	
OIP3	OIP3 measured @ 8 GHz Two tone F1-F2= 10MHz	dB		20	
Noise Figure		dB		1.1	1.4
RF Input Impedance	Reference to 50 ohms VSWR			1.8:1	2.0:1
RF Output Impedance	Reference to 50 ohms			1:5:1	2.0:1
Stability Factor K	Unconditionally Stable		1		
Stability Factor B1	Unconditionally Stable		0		
Supply Voltage Positive:		V		+12	
Supply Current Positive:		mA		100	

Notes:

1/ Unconditional Stability: ( $K > 1$ ) and ( $B1 > 0$ )

Customized configurations of the above specifications are available

### Typical Performance

### Noise Figure @ 23C

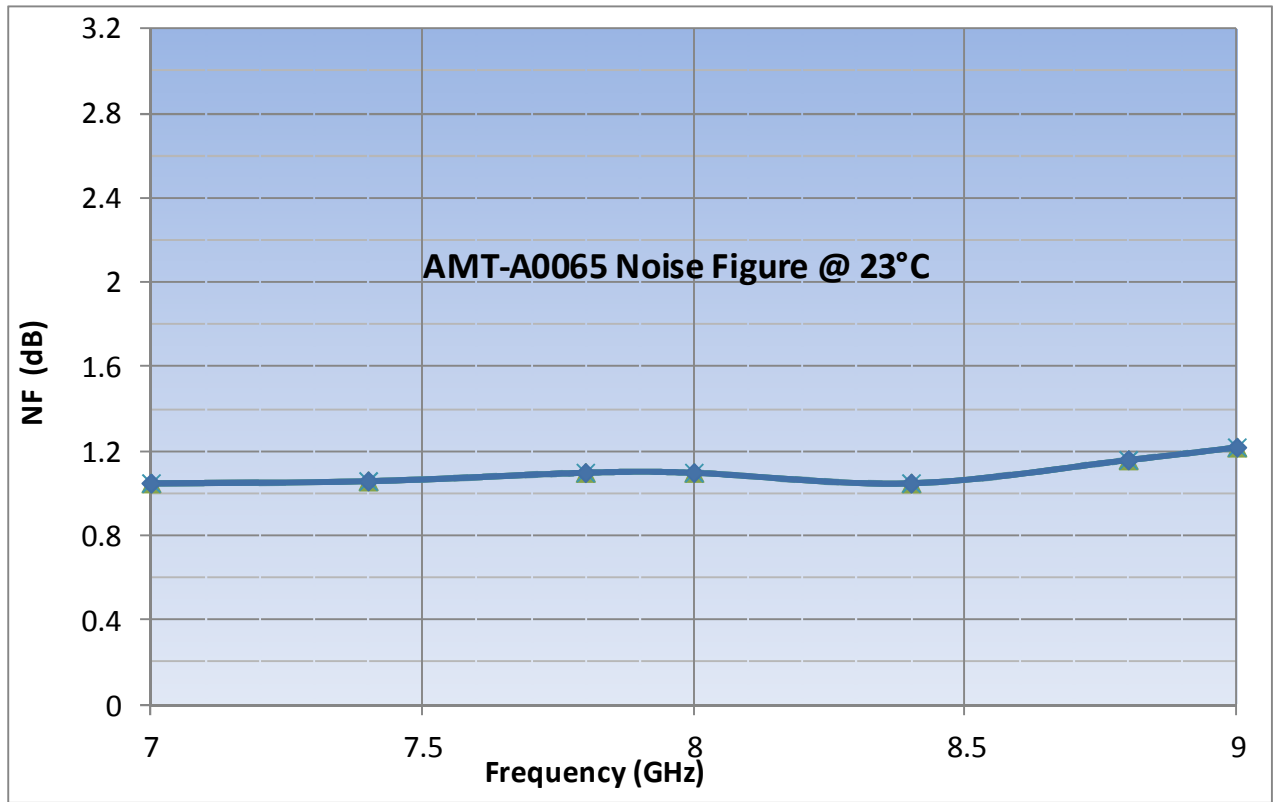

### Typical Performance Power Input / Power Output 8GHz @ 23°C

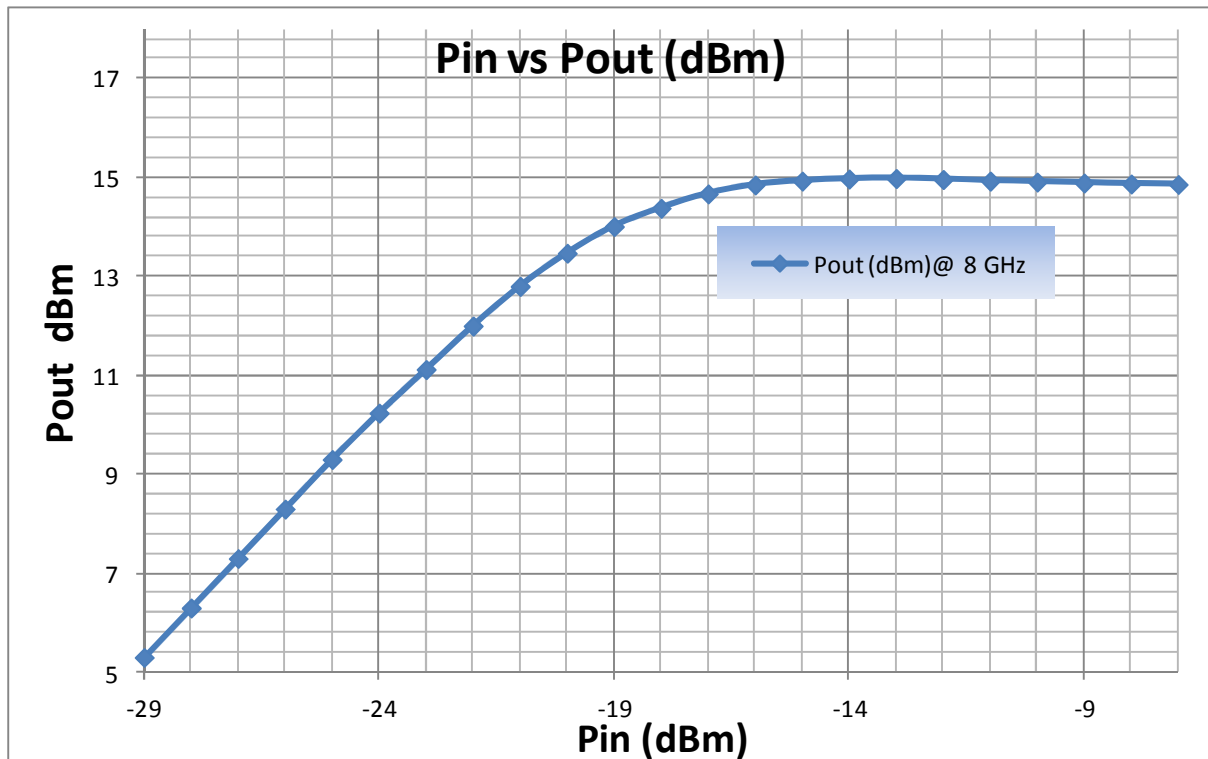

**Package Outline: M004 SMA Connectorized (inches)**

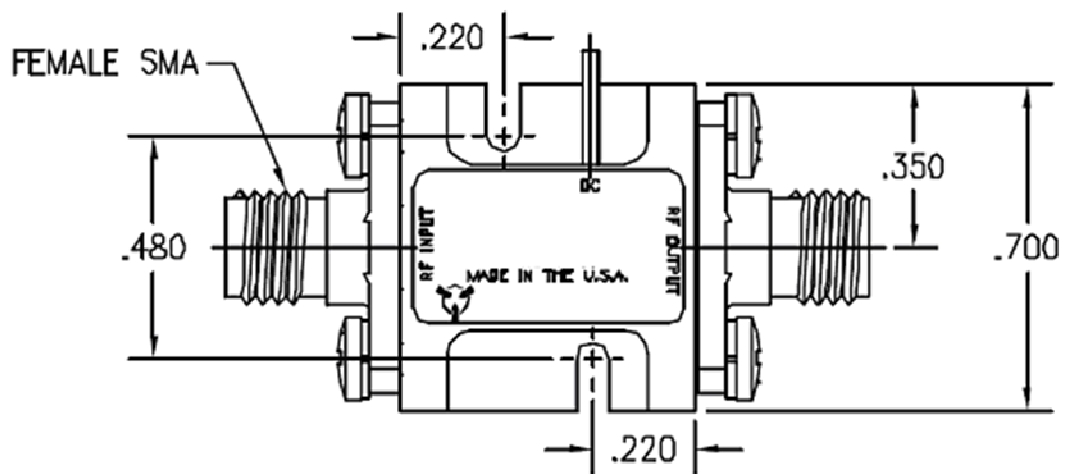
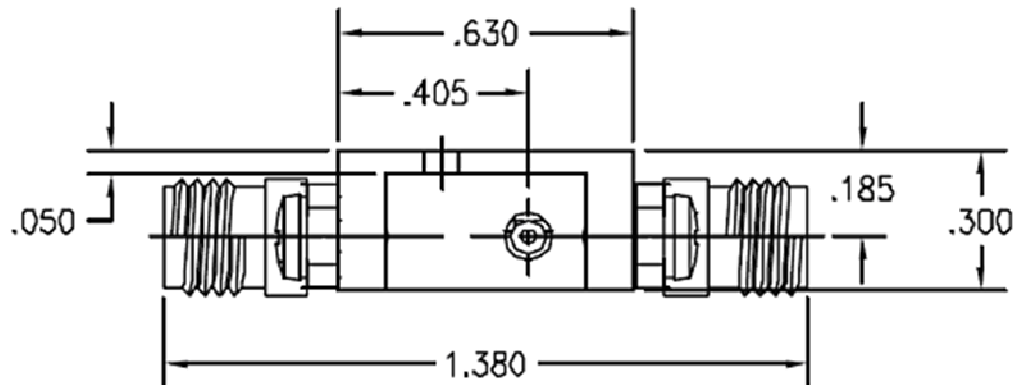

<b>Model Number</b>	<b>Description</b>	<b>Hermeticity</b>	<b>Package</b>
AMT-A0065	SMA Female	Non-Hermetic	Outline: M004
AMT-A0065-H	SMA Female	Hermetic	Outline: M004

Contact us for custom configurations and special requirements.

Our highly experienced team of engineers can quickly identify and implement innovative solutions using latest technology to improve performance and reduce cost.

- Add additional functionality: Input limiter, Temperature compensation, Amplitude/Phase matching, Amplitude/Phase Tracking, Automatic Gain control, Gain sloping, Bypass path, Specific supply voltage, Regulation, Power detector, Health status, and others
- Integrated: Filters, Switches, Limiter, Digital attenuator, Phase shifter, Microcontroller, Multiple amplifiers, Switch matrix, Comb generators and others
- Mechanical: Custom packages - Surface Mount, Connectorized, Waveguide, Carrier, Drop-in, Hermetic and others

Agile Microwave Technology Inc is the logical choice for all your commercial or military RF/Microwave components/module requirements.

## Contact Information:

**101 Bloomingdale Road  
Hicksville, NY 11801**

**Phone: (516) 931-1760**

**Fax: (212) 374-1153**

**[info@agilemwt.com](mailto:info@agilemwt.com)**

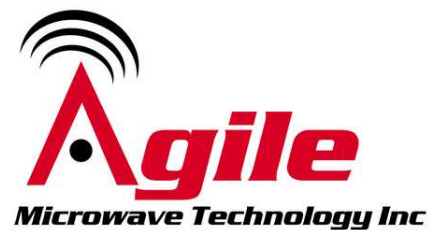

**[www.agilemwt.com](http://www.agilemwt.com)**

AMTI reserves the right to change at any time without notice the design, specifications, function/form or availability of its products described herein. The buyer/customer has the responsibility to validate the performance for their applications. No liability is assumed as result of use of this product and no patent licenses are implied. AMTI reserves all rights.